

INSTRUCTIONS FOR THE USE AND CARE OF ZANUSSI WASHING MACHINES

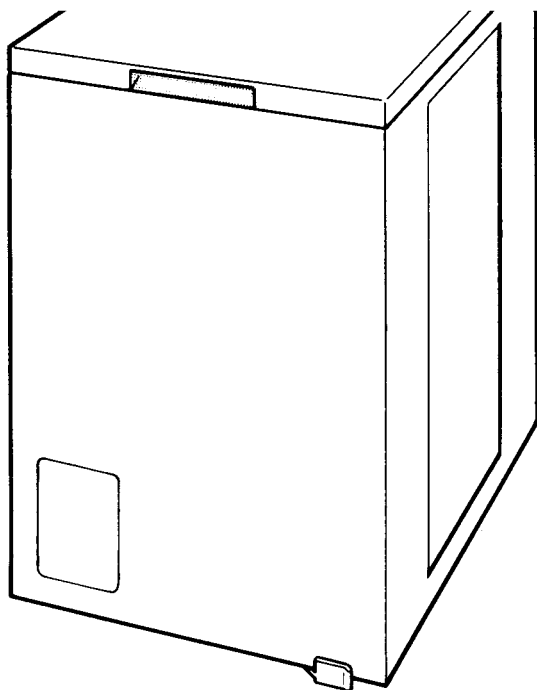

MODEL NO TL 1033

ZANUSSI
The appliance of science

Contents

Page	5	Installation
	10	Getting to know your machine
	16	Using your machine
	20	Additional programmes
	21	Looking after your machine
	23	Helpful washing hints
	24	How to wash...
	26	Servicing
	27	ZANUSSI guarantee conditions
	28	ZANUSSI 5 year cover

Please note that the specifications of your appliance may differ slightly from those shown in this leaflet.

Installation

Unpacking

Having removed the outer carton, reinforcing angles and polythene wrapping, you must take out the internal packing which protected the appliance's «works» during transit.

1
Undo and remove the four bolts from the back of the appliance (figure 1).

2
Each bolt leaves behind a cardboard spacer inside the machine, this should be worked loose by inserting a screwdriver into the bolt hole and allowing it to drop to the bottom of the machine.

3
Tilt the machine backwards and remove the two inner angle packings by pulling the two cardboard bands (figure 2). Pull out the right band A first and then the left band B.

4
Lift the machine and remove the polystyrene base packing.
It is advisable to keep all parts of the inner packing for re-use in case the machine has to be transported again.

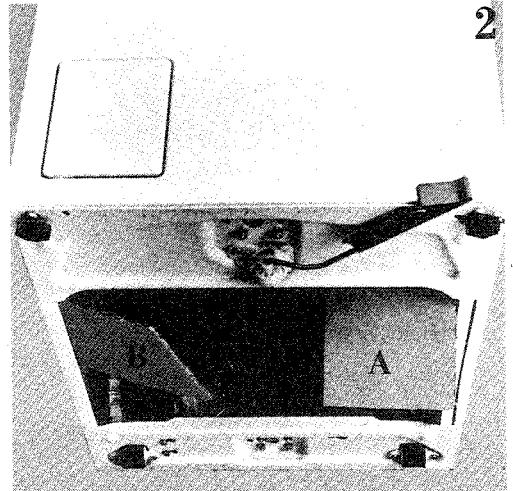
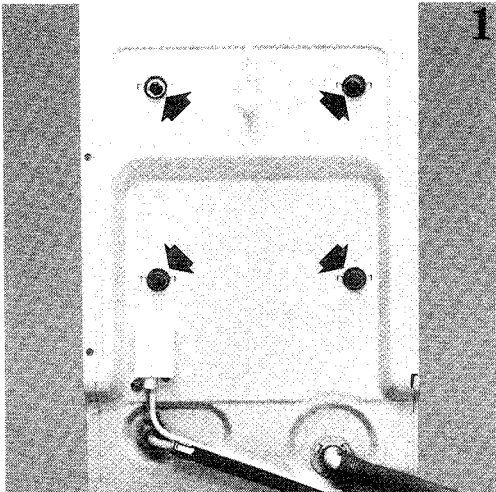

Positioning and levelling

To allow easy movement, the machine is fitted with 2 fixed wheels located at the rear of the base plus a third small retractable wheel which can be dropped by turning the special lever (fig. 3-4) to the left.

To steady the machine, return the lever back to its original position (fig. 3).

To keep vibration, noise and movement to a minimum, it is essential that the machine is absolutely level. Check this with the aid of a spirit level when the machine is in its permanent operating position. Any adjustments needed can be made by raising or lowering the two adjustable feet at the front of the machine — you merely screw them up or down (figure 5).

Some vibration is inevitable, especially if mounted on a wooden floor, so make

sure there is a gap of at least 12mm ($\frac{1}{2}$ ") between the machine and any walls, furniture and so on.

The plumbing connections

In order to make your new Zanussi washing machine as convenient to use as possible it has been designed to be permanently plumbed-in to your home's water supply and drainage system. However, if this is not possible it may be connected to suitable existing taps, with the drain hose discharging into a sink.

Tap connections

For $\frac{3}{4}$ " diameter gas thread tap connectors simply attach to $\frac{3}{4}$ " diameter inlet hoses on the machine. For any other diameter you will have to get special adaptors, either from a plumber or a

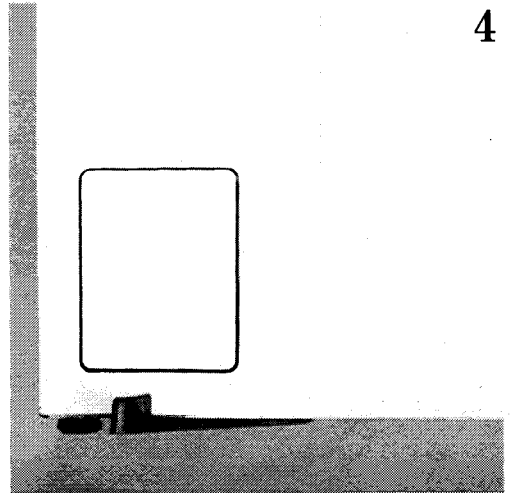
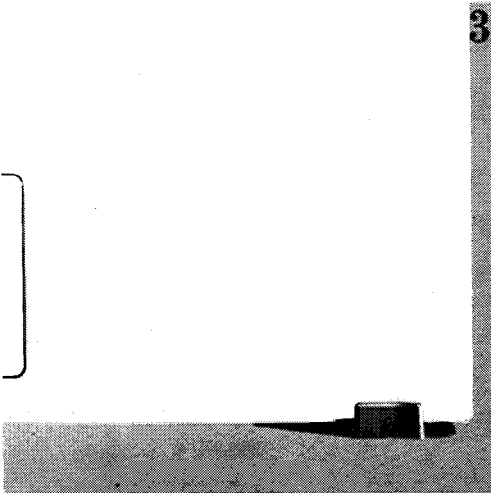

good hardware store, to accept the couplings on the machine's inlet hoses. The inlets in the back of the machine are colour coded: red for hot, blue for cold. Before operating the machine, be sure to connect the hose to the hot inlet to the hot tap, and the hose to the cold inlet to the cold tap.

Plumbing in

Several firms now offer kits enabling you to plumb-in a washing machine yourself. Provided your home's plumbing is relatively modern, and you are reasonably handy and careful to follow the instructions supplied with the kit to the letter, you should be able to do a satisfactory job. However, if you are at all unsure about your ability to carry out the work correctly, don't take risks with your new machine — get a qualified plumber to do the job for you.

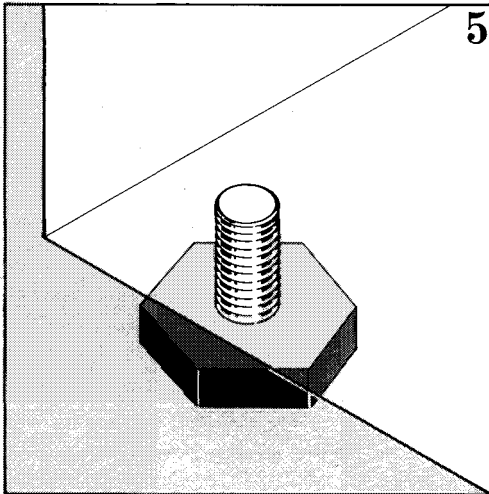

Plumbing technicalities

In addition to complying with the wishes of the Water Authority and Building Control Officer, there are a few other technicalities you must bear in mind if your new machine is to work properly.

1

The machine must be given a separate hot and cold water supply. You should not connect it to a mixer tap, or to a single outlet water heater. If only cold water supply is available connect the two hoses to a cold water outlet by means of «Y» connection piece.

2

A certain amount of water pressure is needed for the machine to fill with reasonable speed. If you cannot make the cold water connection direct to the rising main — and many water authorities will object if you do — check that the height between the machine's inlet and the bottom of the cold water storage cistern is at least 4.25m (14ft). As for the hot water storage cylinder, you will have sufficient pressure if the height between the machine's inlet and the bottom of the cold water storage cistern — (not between machine and hot water cylinder, as many people think) is at least 2.4m (8ft). If there is insufficient cold water or hot water pressure, you may still be able to operate the machine successfully by removing the small restrictor contained in the hot or cold water inlets to the machine. To get at this, simply disconnect the water supply hose from the inlet, pull out the inlet's mesh filter to gain access to the restrictor which can be removed with the aid of a pair of thin nosed pliers.

3
If you intend the drain hose from the machine to empty into a sink, make sure the sink is empty and that the plug hole is not blocked.

4
Where the machine is permanently plumbed in, it is best to hook the end of the hose into a drain-pipe installed for the purpose. It should have an internal diameter of at least 38mm (1½") thus leaving an air gap between hose and pipe, and should be designed in such a way that the water level within it never covers the end of the hose.

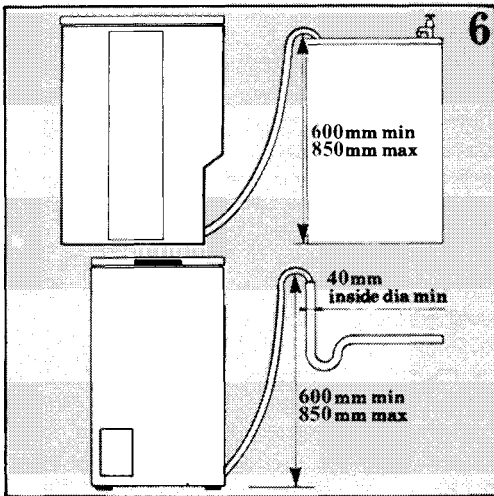

Important: Before connecting up the machine to new pipework or to pipework that has not been used for some time, run off a reasonable amount of water to flush out any debris that may have collected in the pipes.

5
Whether discharging into a sink or a drain-pipe check that the end of the drain hose is neither too high nor too low. The top of the curve in the hose's end should be no more than 85cm (34in) and no less than 60cm (23in) above floor level (fig. 6).

6
Finally, make sure that with the machine in position, the drain hose is not obstructed, blocked or bent so sharply that water cannot flow freely.

The electrical connections

WARNING:
THIS APPLIANCE
MUST BE EARTHED

The manufacturer declines any liability should this safety measure not be observed.

If the plug that is fitted to your appliance is not suitable for your socket outlet, it must be cut off and the appropriate plug fitted. The cut off plug should be disposed of to prevent the hazard of electric shocks in case it should be plugged into a 13 Amp socket in another part of your home.

IMPORTANT

The wires in this mains lead are coloured in accordance with the following code:

GREEN AND YELLOW - EARTH

BLUE - NEUTRAL

BROWN - LIVE

If you fit your own plug, the colours of the wires in the mains lead of your appliance may not correspond with the markings identifying the terminals in your plug, this is what you have to do: Connect the green and yellow (earth) wire to the terminal in the plug which is marked with the letter «E» or the earth \perp symbol or coloured green, or green and yellow.

Connect the blue (neutral) wire to the terminal in the plug which is marked with the letter «N» or coloured black.

Connect the brown (live) wire to the terminal which is marked with the letter «L» or coloured red.

The plug moulded on to the cord incorporates a fuse. For replacement, use a 13 Amp BS 1362 fuse. Only ASTA approved fuses should be used.

The fuse cover/carrier must be replaced in the event of changing fuse.

The right fuse cover/carrier colour is the one shown by the coloured insert at the base of the plug.

The plug must not be used if the fuse cover/carrier is lost. A replacement cover/carrier must be obtained from Zanussi Service Agents whose addresses are listed on the attached «Zanussi Service Agents Nationwide».

This appliance complies with E.E.C. directive no. 82/499 of 7.6.82 relative to radio interference suppression.

Getting to know your machine

The controls and how to use them

A Programme chart (on detergent dispenser lid).

B Detergent dispenser

C Pilot light

D Programme selector dial

E Economy button 

F Spin speed button 500-1000

G Half load button 

H Drain filter

A Programme chart

This chart will help you to select the correct wash programme. The letter and wash programme numbers correspond to those used in the detailed charts on pages 12-15.

B Detergent dispenser

The dispenser has three compartments — two for detergent (**a** and **b**) and one for fabric conditioner (**c**), (see figure 8 page 18).

The fabric conditioner compartment is fitted with a removable small lid. To open the dispenser, pull the handle which is at the lower half, upwards gently.

C Pilot light

The pilot light comes on when the machine is set to start.

G Half load pushbutton

By pressing this before selecting a wash programme the intake of water is reduced. This is useful if you want to wash half loads, 2kg (4½lb) instead of the usual 4.5kg (10lb) of cotton or linen items. By reducing the water consumption you will use less electricity.

The half load programme is not suitable for synthetic or mixed fabric, delicate articles or wool. These fabrics all need a high water level to avoid creasing.

F Spin speed pushbutton

If this is pressed in at the beginning of an **energetic** wash cycle, this push button provides the final spin at 500 rpm instead of 1000 rpm.

E Economy push-button

By pressing in this push-button prior to selecting wash cycle B or C, you will obtain a reduction of the wash temperature from 95°C to 60°C whilst the duration of the programme will remain practically unchanged. This will ensure a substantial saving in electricity consumption.

It is advisable to press in this pushbutton particularly when washing strong white fabrics which do not have stubborn stains.

D Programme selector dial and start/stop knob

The selector dial is marked with letters corresponding to those on the chart. To set the machine to the correct programme (see programme chart and table on pages 12-15) push the dial in and turn it clockwise until the letter you want coincides exactly with the red pointer. Never attempt to turn the control dial in an anti-clockwise direction. To start the machine, pull out the knob. If the knob does not come out easily check that the pointer is in line with the selected letter — if it is not, reset the dial.

To stop the machine during a cycle, push the dial in. At the end of the programme push the dial in and the pilot light will go out. The machine will have stopped automatically. The red line on the dial indicates an energetic wash programme. The blue line on the dial indicates a gentle wash programme.

H Drain filter

This is situated behind the small flap door at the base of the cabinet. It will need cleaning from time to time. (See pages 21-22).

The washing programmes

The washing machine has 11 programmes and 8 additional programmes such as «rinse» or «spin only» (see charts pages 12-15). Each washing programme is designed for a specific type of fabric, for example cotton, nylon, mixed fabrics such as polycotton, etc. They follow the International Textile Care Labelling Code (ITCLC) which is used for wash labels on garments and household linen as well as on washing powder packets. This makes it simple to choose the right programme for the fabric you are washing.



The Energetic wash cycle for robust fabrics (B-F) are completely automatic, taking the clothes through washing, rinsing, spinning and draining.

The Gentle wash cycles (L-Q) are for minimum iron, drip dry and delicate fabrics. The machine stops after the last rinse before the water draining and spinning. The clothes are left suspended in water to prevent them becoming creased by remaining in the bottom of the wash tub in a damp state after spinning. To complete the cycle, turn the programme selector dial to cycle V for water draining followed by a short spin, or to cycle Z for drain only if you are washing drip dry articles.

The woollens programme (R) and quick wash programme (S) are both automatic, taking the clothes through washing, rinsing, spinning and draining.

Energetic wash cycle

For cotton, linen and viscose (rayon) fabrics
Recommended wash load: 4.5 kg (10 lb) max

Wash cycle Position of programme selector	Dispenser compartments		Wash cycle description and fabric guide
	a b washing powder	c fabric conditioner	
A Prewash	a		Cottons and linens Prewash (30 mins.) in water at 40°C (high level) followed by a soaking phase — the laundry is left soaking in the water. To drain the water, turn the programme knob to cycle V (drain with a gentle spin) or Z (drain only).
B * Whites - heavy soil 	a b	c	White cottons and linens without special finishes. Prewash in water at 40°C (normal level). Main wash in water at 95°C (normal level). 4 cold water rinses (high level). Spinning.
C * Whites 	b	c	White cottons and linens without special finishes. Main wash at 95°C (normal level). 4 cold water rinses (high level). Spinning.
D Fast Coloureds 	b	c	Cotton, linens and viscose. Main wash in water at 60°C (normal level). 4 cold water rinses (high level). Spinning.

* With these wash programmes you may use the «Economy» pushbutton, if so required. See page 10.

Wash cycle Position of programme selector	Dispenser compartments		Wash cycle description and fabric guide
	a b washing powder	c fabric conditioner	
F Non-fast Coloureds 	b	c	Cottons, linens and viscose. Main wash in water at 40°C (normal level). 4 cold water rinses (high level). Spinning.
G Rinses		c	Cottons, linens and viscose. 4 cold water rinses (high level). Spinning.
H Special treatments		c	Cottons, linens and viscose. Intake of water mixed with liquid additive such as fabric conditioner (high level). Spinning.
J * Spin only			Spinning for about 6 minutes with simultaneous water draining. This is preceded by slow rotations of the drum.

* It is important when selecting this programme that the selector dial is accurately lined up with the programme letter «J». This is because the spin cycle has to be preceded by a slow drum rotation to enable spin start up.

Water filling

30°/40°/50°C programmes — cold water filling

60°C programmes — hot and cold filling

95°C programmes — hot water filling only.





Should you need to check the water filling temperature, use the above information for guidance.

Gentle wash cycle

For delicates, synthetics including acrylics, acetates, triacetates, machine-washable woollens and synthetics mixed with polyester and wool.

Recommended wash load: 1.5-2 kg (3-5 lb);



wool max: 1 kg (2 lb)

Wash cycle Position of programme selector	Dispenser compartments		Wash cycle description and fabric guide
	a washing powder	b fabric conditioner	
L White Special cottons 	b	c	Cotton articles with special finishes drip-drying. Main wash in water at 95°C (high level). 3 cold water rinses (high level).
M Whites 	b	c	White nylon and polyester/cotton mixtures. Main wash in water at 60°C (high level). 3 cold water rinses (high level).
N Minimum Iron 	b	c	Coloured synthetics and mixed fabrics. Main wash in water at 50°C (high level). 3 cold water rinses (high level).
P Delicates 	b	c	Acrylics, acetates, triacetates and wool mixtures. Main wash in water at 40°C (high level). 3 cold water rinses (high level).
Q Silk 	b	c	Silk and printed acetate fabrics. Main wash in water at 30°C (high level). 3 cold water rinses (high level).

Note: There is no water draining after the last rinse of most of the gentle wash cycles. This prevents the clothes from creasing if they are left in the machine at the end of the wash cycle.

The clothes are held suspended in water until you turn the selector dial to V when the water will be drained and the clothes will be given a gentle spin. Or the selector dial can be turned to Z when the water will drain away without spinning.

Warning: Do not open the machine door until one of the draining programmes has been completed. If you do, there will be a flood.

Wash cycle Position of programme selector	Dispenser compartments		Wash cycle description and fabric guide
	a b washing powder	c fabric conditioner	
R Woollens  	b	c	Machine washable woollens and mixtures with cotton or viscose; blankets. Main wash in water at 40°C (high level). 3 cold water rinses (high level). Short spin.
S Quick-wash	b	c	Delicates, lightly soiled. Main wash in water at 30°C (high level). 3 cold water rinses (high level). Short spin.
T Rinses		c	3 cold water rinses (high level). Short spin.
U Special treatments		c	Intake of water mixed with liquid additive such as fabric conditioner (high level). Short spin.
V Short spin only			Water draining followed by a short spin.
Z Drain			Water draining with a steady drum.

Using your machine

Sorting the wash

Sort the clothes and household linen according to fabric, colour fastness and degree of soiling, following the charts on pages 12-15. Check with the wash care label sewn to the garment or article; this should have a number in a wash tub symbol which corresponds with the number shown on the charts. For example, if your sheets have a label with number 1 in the wash tub you can choose either programme B or C depending on whether the articles are lightly or heavily soiled. If the garment has no label, choose the appropriate programme for the fabric. If you are uncertain what fabric this is, always choose one of the gentle wash cycles such as N or P. Be cautious with coloured items unless they are labelled colourfast, wash them separately by hand, or use the programme for non-fast coloureds.

For the best results wash a full load.

4.5kg (10lb) of cottons

1.5-2kg (3-5lb) synthetics

1kg (2lb) machine washable woollens.

Until you are familiar with the size of a full load, weigh the articles on the kitchen or bathroom scales. Try to mix large and small items in each load.

If you cannot make up a full load of similar items (e.g. cotton sheets and towels) make up a load of any polycotton and cotton items, and use one of the lower temperature washes (N-50°C).

Remember, however, that white cotton and linen should be washed at a higher temperature (95°C) every third wash to keep them a good colour.

The half load programme is also useful, if you cannot make up a full load of cottons and linens.

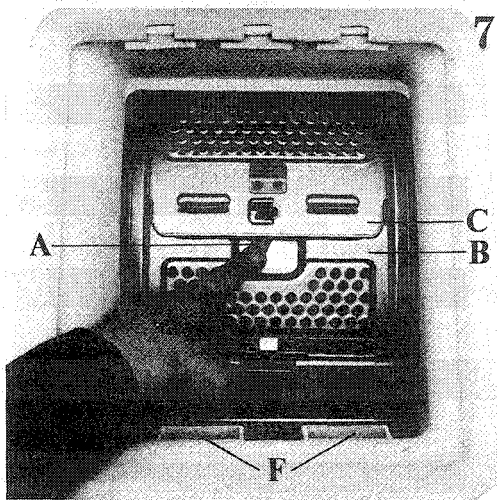

7 Loading the clothes

Lift the lid on the machine and turn the drum by hand until the loading door appears (fig. 7).

Push safety lever A (fig. 7) to the right and press it down until flap door C (fig. 7) disengages. Fasten drum flap door B into the special slits F provided for the purpose, and then place the clothes in the drum taking care to spread them out evenly.

Put the sorted clothes into the drum one by one, shaking them out first.

Alternate large and small items.

Be sure all pockets are empty, buttons and zips fastened. Avoid washing frayed or torn articles, and treat stains such as paint, ink, rust and grass before washing (see page 25).

Once the machine is loaded close the loading door by overlapping flap C on flap B, making sure that safety lever A returns to its original position. Close the lid and then put the washing powder and conditioner (if required) into the dispenser.

Choosing the right washing powder

Always use a low lather powder. This is important as too much lather prevents the articles from tumbling freely and being properly cleansed. **Persil Automatic and Ariel Automatic** are specially designed to complement the cleaning action of the machine.

Filling with washing powder

The washing powder dispenser has three compartments (figure 8). Compartment «a» is for the prewash powder, «b» for the main wash powder, and «c» for fabric conditioner. The same wash powder can be used for the pre and main wash cycles. Lift the lid of the dispenser and add the measured amount of powder, following the directions on the wash powder packet (see also Table on next page).

Be sure to use enough powder — this is essential to get the clothes really clean. Once the dispenser is filled, close the small lid dispenser.

To allow use of liquid detergents, instead of powder, a special dispenser is available. This accessory is obtainable on request.

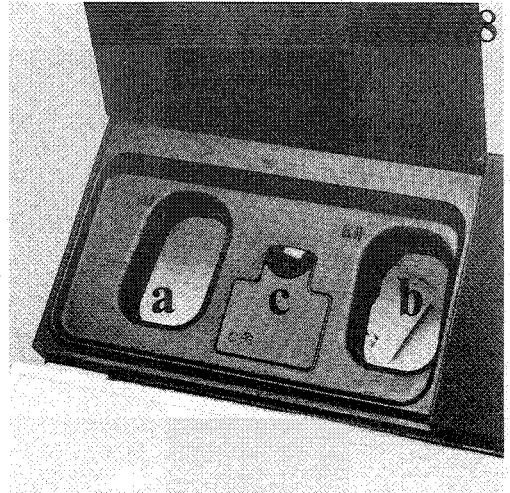

Amount of wash powder in grammes for a full load.

Hardness	Pre-wash	Main wash following pre-wash	Main wash
Soft	20	90	100
Average	60	135	160
Hard	90	190	230
Very hard	125	220	240

For half loads use half quantity.

For information regarding the degrees of hardness of water in your area, ask the local Water Authority.

Using fabric conditioners

When you want to use a conditioner, take the lid off and put the measured amount (follow manufacturer's instructions) into compartment «c» in the dispenser at the same time as you put in the washing powder. **Be careful not to fill the compartment above the level marked «MAX».**

The conditioner will be automatically used by the machine at the appropriate time.

To start the machine

Check that:

- the main switch is on;
- the lid is properly closed;
- the water is turned on.

Select the programme required by pushing in and turning the programme selector dial clockwise to the required letter. Pull out the dial. The pilot light will then come on and the machine will start. The machine will automatically carry out all the operations up to the end of the chosen programme. Then it will stop.

The pilot light goes out.

If, after the start of a programme, you find you have selected the wrong one, push the selector dial in to stop the machine. Then turn the dial clockwise to the correct position and pull the dial out to restart the washing cycle.

At the end of the programme push the dial in to switch the machine off.

Unloading the clothes

The lid remains automatically locked for 1-2 minutes after the machine has been switched off. You can then open the lid and unload the machine. **If you have been using a gentle wash cycle do not forget to set the machine to drain the water (programme V or Z) before opening the lid.**

Additional programmes

Economy programme

Use this programme for lightly soiled loads of cotton or linen. Press in the pushbutton marked **E** and then select either programme B or C.
See page 10.

Half-load programme

Use this for smaller loads of cotton and linen items – 2kg (4lb) max. Press in the pushbutton marked ½, then select the appropriate programme. Do not, however, use any of the gentle action programmes as these need a higher water level, than is allowed for the half-load programme.
See page 10.

Spin only

This programme can be used to remove water from hand washed articles or any laundry which may have got wet but does not need washing. For example, washing left on the line during a rainstorm. See pages 13 and 15.

Special treatments

If you want to treat an article with fabric conditioner without washing it first, you can do this on either programme H or U.

Looking after your machine

Important: Make sure that the machine is unplugged and the water taps turned off before undertaking any kind of maintenance.

General care and cleaning

After each wash leave the lid ajar for about two hours, to allow air to circulate freely inside the drum.

From time to time clean plated, polished and plastic parts with a soft damp cloth. Never use abrasive powders.

Wipe over the exterior cabinet with a lukewarm solution of a mild liquid cleaner, rinse and dry thoroughly. From time to time, apply a little wax furniture cream with a soft cloth.

If the washer has been out of use for a long time, carry out a complete cycle (F) without washing a load, adding 25g (1oz) Calgon water softener to the detergent dispenser instead of wash powder. This will remove any deposits from the machine.

Cleaning the drain filter

This is only necessary if some object such as a safety pin or pebble, or excess fluff, blocks the drain and obstructs the normal flow of water. If you have to clean it, detach the drain hose from its hanger at the back of the appliance and place the free end in a basin at floor level to collect any excess water. Place a small bowl on the floor under the exposed filter to catch any water.

1. Open the flap door of the filter compartment by pressing it inwards with a finger at the hinged side (as shown in fig. 9).
2. Shift safety slider A (fig. 10) until the red notch B (fig. 10) disappears.
3. Turn the filter knob anticlockwise and pull the filter out. Underneath the filter there is a small extractable gutter which makes it easier to collect any residual water that might flow out when the filter is removed.
4. Clean filter thoroughly.
5. Refit the filter into the special guides C (fig. 11) and turn the knob clockwise until the red notch reappears.

Cleaning inlet filters

These are situated at the back of the machine and should be inspected from time to time. Unscrew the hoses and remove the mesh filter lodged just inside the hose. Run them under a fast running tap to remove any sediment. Replace the wire filters and the hoses firmly.

Cleaning the washing powder dispenser

We recommend that the washing powder dispenser is checked regularly to ensure that it is clean and dry.
Do wipe dispenser after each wash.

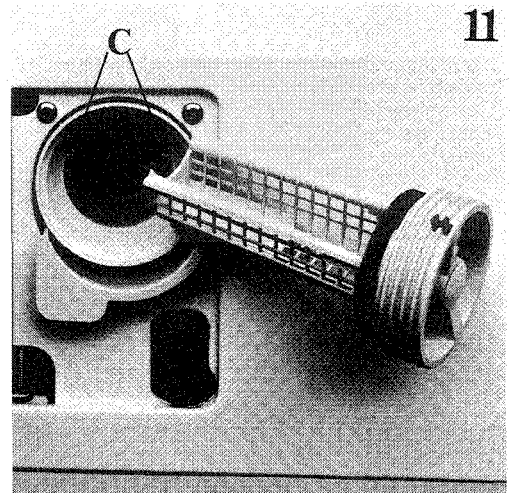
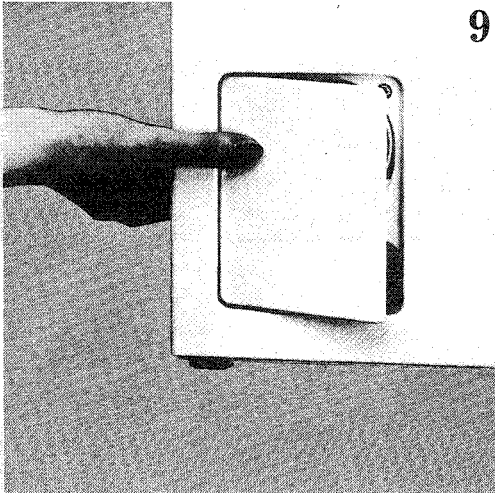
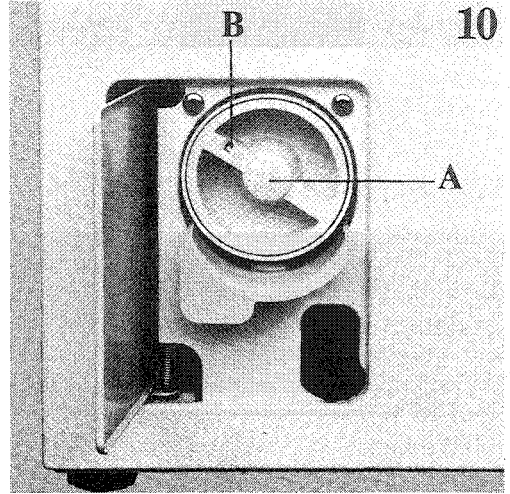

Helpful tips for successful washing

Here are some practical hints to help you get the best washing results.

Don't overload the machine. The clothes will not move round freely if there are too many of them and the washing powder may not dissolve properly.

Always use a low suds washing powder specially made for washing machines. Excessive foaming gives an unsatisfactory wash and may even harm the machine. The quantity of washing powder required depends on the amount of laundry and how soiled it is. It may therefore be necessary to vary the quantities suggested on page 19. You will be able to tell if you need to do this when you are used to the machine.

Don't put washing powder into the dispenser until just before starting a programme. If the powder is left for any length of time in the dispenser it may form lumps which are difficult to dissolve.

For best results do not wash more than 1kg (2lb) of woollen articles at a time.

Wash only woollen articles marked «machine washable».

For best results do not wash more than 1.5-3kg (3-5lb) of synthetic fabrics in one load. Synthetic fabrics need plenty of room to move around or they tend to crease.

Clothes should be sorted according to the fabric — colour fastness and degree of soiling (see page 12).

Mend open seams and tears before washing.

Cloze zips, secure buttons.

Collect laces, washable belts etc and put them in a bag for washing.

Empty pockets. **(This is important as should a coin become lodged between the tub and drum it can cause extensive damage).** See final paragraph page 26.

Remove spots of rust, paint, ink and grass stains before washing (see instructions page 25).

Don't wash light coloured fabrics with dark ones. One may leave specks of fluff on the other.

Don't risk washing coloured articles unless you are sure they are colourfast. It's worth hand washing the article to find out.

If you live in a hard water district, you can add Calgon water softening powder to the washing machine in compartment «b». For the quantity of Calgon to use, see packet directions.

How to wash

Nappies

Leave the soiled nappies soaking in a solution of proprietary nappy cleaner. When there are sufficient for a wash, drain off the water and rinse by hand in cold water (this is advisable as some nappy cleaners have an adverse effect on the rubber lid seal), then transfer the nappies to the washing machine. Set the selector dial to J (fast spin) to remove the excess solution. Then wash the nappies on programme C (whites). Dry and air them thoroughly.

Blankets

Only wash blankets which are labelled as suitable for machine washing. Use wash programme R (woollens with a short spin which will remove the excess water and leave the blanket ready to tumble dry or hang out on a line).

Curtains

Check that the fabric is washable. Remove all the curtain hooks and if the heading is drawn up by means of curtain tape, release the strings to allow the fabric to spread flat. Weigh the curtains and decide if you can wash them in one or more loads. Select the correct

programme for the fabric. If the curtains have not been washed for some time they may be dusty, in which case it is a good idea to rinse them on programme G or T according to the fabric. After draining, start the suitable wash programme.

Dyeing

You can dye fabrics successfully in the machine but it is essential to buy a good proprietary dye and to read the manufacturer's instructions carefully. Make sure that the fabric is suitable. The dye instructions will guide you on this point. Then wash the article to make sure it is thoroughly clean, using programme C or M according to the fabric. Then follow the instructions for machine dyeing.

Immediately after you have removed the dyed material from the machine, set it to programme F to clean all traces of dye from the machine.

It is not absolutely necessary to add washing powder to the dispenser for this, however you can add it if you prefer.

Stain removal

Some stains will not be removed in the wash. It is wise to treat them before laundering.

The following are simple but effective treatments to use on any washable fabric. Treat the stain as soon as possible and launder afterwards to remove any residual stain.

Ballpoint and felt-tip ink:

Dab with methylated spirit on cotton wool (not on acetate or triacetate fabric).

Fountain pen ink:

Sponge with cold water to flush out as much ink as possible, or hold the fabric under running cold water. Launder and treat any remaining stains with lemon juice.

Grass stains:

Dab with methylated spirit (not on acetate or triacetate). Rinse in clear water.

Oil:

If heavy stains from cycle or car oil do not come out in the wash, treat them with a proprietary grease solvent.

Paint: Emulsion:

Sponge immediately with cold water and then launder. If the stain has dried, soften it with methylated spirit or a proprietary paint brush cleaner. (Test an inconspicuous corner of the fabric first).

Gloss:

Dab with methylated spirit or proprietary paint brush cleaner. (Test fabric first).

Rust (iron mould):

Rub with lemon juice and then sprinkle salt over the stain and leave for an hour. If subsequent washing does not remove the stain, use a proprietary rust cleaner following manufacturer's directions.

Servicing

If, having followed these instructions carefully, your machine fails to work properly, contact your local Zanussi Service Network. Before you do that, though, it is worth making a few simple checks yourself.

If the machine won't start...

Ensure that the programme control dial on the machine is pulled out into the «on» position.

Make sure that the lid of the machine is firmly shut.

Make sure that the appliance is properly plugged in and that the socket switch (if any) is in the «on» position.

Check that there is power at the socket by plugging in an appliance you know to be working — a small lamp, for example. If this too fails to work, check the main circuit fuses in your home's consumer unit or main fuse box.

If the machine won't fill...

Make sure the supply hoses are not sharply bent.

Make sure taps and stop-cocks are turned on.

Check that there is sufficient water pressure.

If the machine won't drain or spin...

Check that the drain hose is not bent, blocked, or obstructed in some other way.

Check that the drain filter in the machine is not clogged.

If the machine empties as it fills...

Make sure the end of the drain hose is not less than 60 cm (23in) above floor level.

If the machine vibrates badly, or is too noisy...

Check that the machine is absolutely level.

Check that there is sufficient clearance between the machine and nearby wall, furniture, etc.

Check that all the internal packing, plastic spacers and transit security bolts have been removed as described at the start of these instructions.

Failure to observe these checks could result in your being charged for the service call when requested.

Peace of mind for twelve months

ZANUSSI STANDARD GUARANTEE CONDITIONS

This guarantee is in addition to your statutory and other legal rights which will not be excluded or in any way diminished by the return of this guarantee card.

We, IAZ International (UK) Ltd, undertake that if, within twelve months (36 months for TV sets) of the date of the purchase, this ZANUSSI appliance or any part thereof is proved to be defective by reason only of faulty workmanship or materials, we will, at our option, repair or replace the same **FREE OF ANY CHARGE** for labour, materials or carriage on condition that:

The appliance has been correctly installed and used only on the electricity supply stated on the rating plate.

The appliance has been used for normal domestic purposes only, and in accordance with the manufacturer's operating and maintenance instructions.

The appliance has not been serviced, maintained, repaired, taken apart or tampered with by any person not authorised by us.

The appliance is still in the possession of the original purchaser.

All service work under this guarantee must be undertaken by a Zanussi Network Service Centre (or the Zanussi Authorised TV Service Dealer).

Any appliance or defective part replaced shall become our property.

Exclusions

This guarantee does not cover:

Damage or calls resulting from transportation, improper use or neglect, the replacement of any light bulbs or removable parts of glass or plastic.

Costs incurred for calls to put right machines improperly installed or calls to machines outside the UK and the Republic of Ireland.

Appliances found to be in use within a commercial environment, plus those which are the subject of rental agreements.

Television receivers - routine adjustment, or poor reception resulting from a source outside of the receiver.

or five years

ZANUSSI 5 YEAR COVER CONDITIONS

For a once-only payment you can extend your Standard Guarantee to 5 years. All the conditions and exclusions of the Standard Guarantee apply.

Notes

1. Products supplied as «seconds», refurbished, damaged or shop-soiled are not eligible for Zanussi 5 Year Cover.
2. The issue of a cover does NOT by virtue of our having done so, nullify the exclusions.

3. The Engineer will need to check the details of your Cover card and may make a charge for his services if it is not presented to him at the time of his call.

4. The date of purchase, or the date of initial payment (deposit) of the appliance will be deemed the date of commencement of cover.

5. Covers issued are not refundable or transferable.

Guarantee Record

Appliance purchased from _____ on _____
Guarantee card no _____ Model no _____
Serial no _____ (These details may be
Your name _____ taken from your
Address _____ Guarantee Record Card)

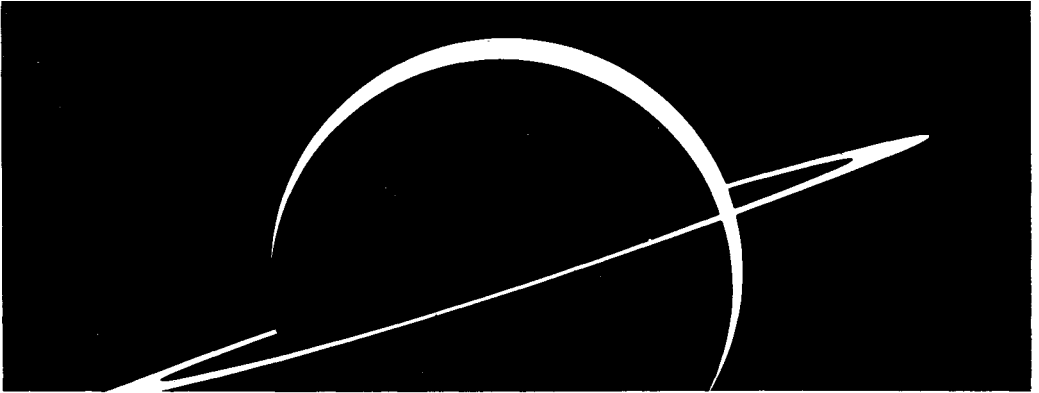

ZANUSSI

The appliance of science

The information in this manual is correct at time of going to press.
Zanussi reserve the right to alter specifications without notice.